

Air Barrier and Insulation Installation Checklist

(Based on IECC 2018 Table R402.4.1.1)



GENERAL REQUIREMENTS

- 1
- Breaks or joints in the air barrier shall be sealed.
 - Air-permeable insulation shall not be used as a sealing material.
 - A continuous air barrier shall be installed in the building envelope.
 - The exterior thermal envelope contains a continuous air barrier.
 - All insulation shall be installed at a Grade I quality in accordance with ICC/RESNET 301

FRAMING INSPECTION

2	<input type="checkbox"/>	Ceiling/attic	<ul style="list-style-type: none"> • The air barrier in any dropped ceiling/soffit shall be aligned with the insulation and any gaps in the air barrier shall be sealed.
3	<input type="checkbox"/>	Walls	<ul style="list-style-type: none"> • The junction of the foundation and sill plate shall be sealed. • The junction of the top plate and the top of exterior walls shall be sealed. • Knee walls shall be sealed. • Walls are framed to allow the corner to be insulated or continuous insulation is/will be installed.
4	<input type="checkbox"/>	Windows, skylights and doors	<ul style="list-style-type: none"> • The space between window/door jambs and framing, and skylights and framing shall be sealed.
5	<input type="checkbox"/>	Rim joists	<ul style="list-style-type: none"> • Rim joists shall include the air barrier.
6	<input type="checkbox"/>	Floors (including above garage and cantilevered floors)	<ul style="list-style-type: none"> • The air barrier shall be installed at any exposed edge of insulation.
7	<input type="checkbox"/>	Crawl space walls	<ul style="list-style-type: none"> • Exposed earth in unvented crawl spaces shall be covered with a Class I vapor retarder with overlapping joints taped.
10	<input type="checkbox"/>	Garage separation	<ul style="list-style-type: none"> • Air sealing shall be provided between the garage and conditioned spaces.
13	<input type="checkbox"/>	Shower/tub on exterior wall	<ul style="list-style-type: none"> • Exterior walls adjacent to showers and tubs shall be insulated • The air barrier installed at exterior walls adjacent showers and tubs shall separate them from the showers and tubs.
14	<input type="checkbox"/>	Electrical/phone box on exterior walls	<ul style="list-style-type: none"> • The air barrier shall be installed behind electrical or communication boxes or air-sealed boxes shall be installed.
16	<input type="checkbox"/>	Concealed sprinklers	<ul style="list-style-type: none"> • When required to be sealed, concealed fire sprinklers shall only be sealed in a manner that is recommended by the manufacturer. Caulking or other adhesive sealants shall not be used to fill voids between fire sprinkler cover plates and walls or ceilings.

Mass Save offers energy code trainings and Free phone assistance, office visits and project site visits

VISIT: www.MassSave.com | CALL: 855-757-9717 | Email: energycodesma@psdconsulting.com

1/1/2021

Air Barrier and Insulation Installation Checklist

(Based on IECC 2018 Table R402.4.1.1)



INSULATION INSPECTION

2	<input type="checkbox"/>	Ceiling/attic	<ul style="list-style-type: none"> The insulation in any dropped ceiling/soffit shall be aligned with the air barrier.
3	<input type="checkbox"/>	Walls	<ul style="list-style-type: none"> Cavities within corners and headers of frame walls shall be insulated by completely filling the cavity with a material having a thermal resistance of R-3 per inch minimum. Exterior thermal envelope insulation for framed walls shall be installed in substantial contact and continuous alignment with the air barrier.
5	<input type="checkbox"/>	Rim joists	<ul style="list-style-type: none"> Rim joists shall be insulated.
6	<input type="checkbox"/>	Floors (including above garage and cantilevered floors)	<ul style="list-style-type: none"> Floor framing cavity insulation shall be installed to maintain permanent contact with the underside of subfloor decking, or floor framing cavity insulation shall be permitted to be in contact with the top side of sheathing, or continuous insulation installed on the underside of floor framing and extends from the bottom to the top of all perimeter floor framing members.
7	<input type="checkbox"/>	Crawl space walls	<ul style="list-style-type: none"> Where provided instead of floor insulation, insulation shall be permanently attached to the crawlspace walls.
9	<input type="checkbox"/>	Narrow cavities	<ul style="list-style-type: none"> Batts in narrow cavities shall be cut to fit, or narrow cavities shall be filled by insulation that on installation readily conforms to the available cavity space.
11	<input type="checkbox"/>	Recessed lighting	<ul style="list-style-type: none"> Recessed lighting fixtures installed in the building thermal envelope shall be air tight and IC rated.

PLUMBING ROUGH-IN INSPECTION

12	<input type="checkbox"/>	Plumbing and wiring	<ul style="list-style-type: none"> Batt insulation shall be cut neatly to fit around wiring and plumbing in exterior walls, or insulation that on installation readily conforms to available space shall extend behind piping and wiring.
----	--------------------------	----------------------------	--

MECHANICAL ROUGH-IN INSPECTION

8	<input type="checkbox"/>	Shafts, penetrations	<ul style="list-style-type: none"> Duct shafts, utility penetrations, and flue shafts opening to exterior or unconditioned space shall be sealed.
15	<input type="checkbox"/>	HVAC register boots	<ul style="list-style-type: none"> HVAC register boots that penetrate building thermal envelope shall be sealed to the subfloor, wall covering, or ceiling.

FINAL INSPECTION

11	<input type="checkbox"/>	Recessed lighting	<ul style="list-style-type: none"> Recessed light fixtures installed in the building thermal envelope shall be sealed to the finished surface.
2	<input type="checkbox"/>	Ceiling/Attic	<ul style="list-style-type: none"> Access openings, drop down stairs or knee wall doors to unconditioned attic spaces shall be sealed.

Mass Save offers energy code trainings and Free phone assistance, office visits and project site visits

VISIT: www.MassSave.com | CALL: 855-757-9717 | Email: energycodesma@psdconsulting.com

1/1/2021

Air sealing key points

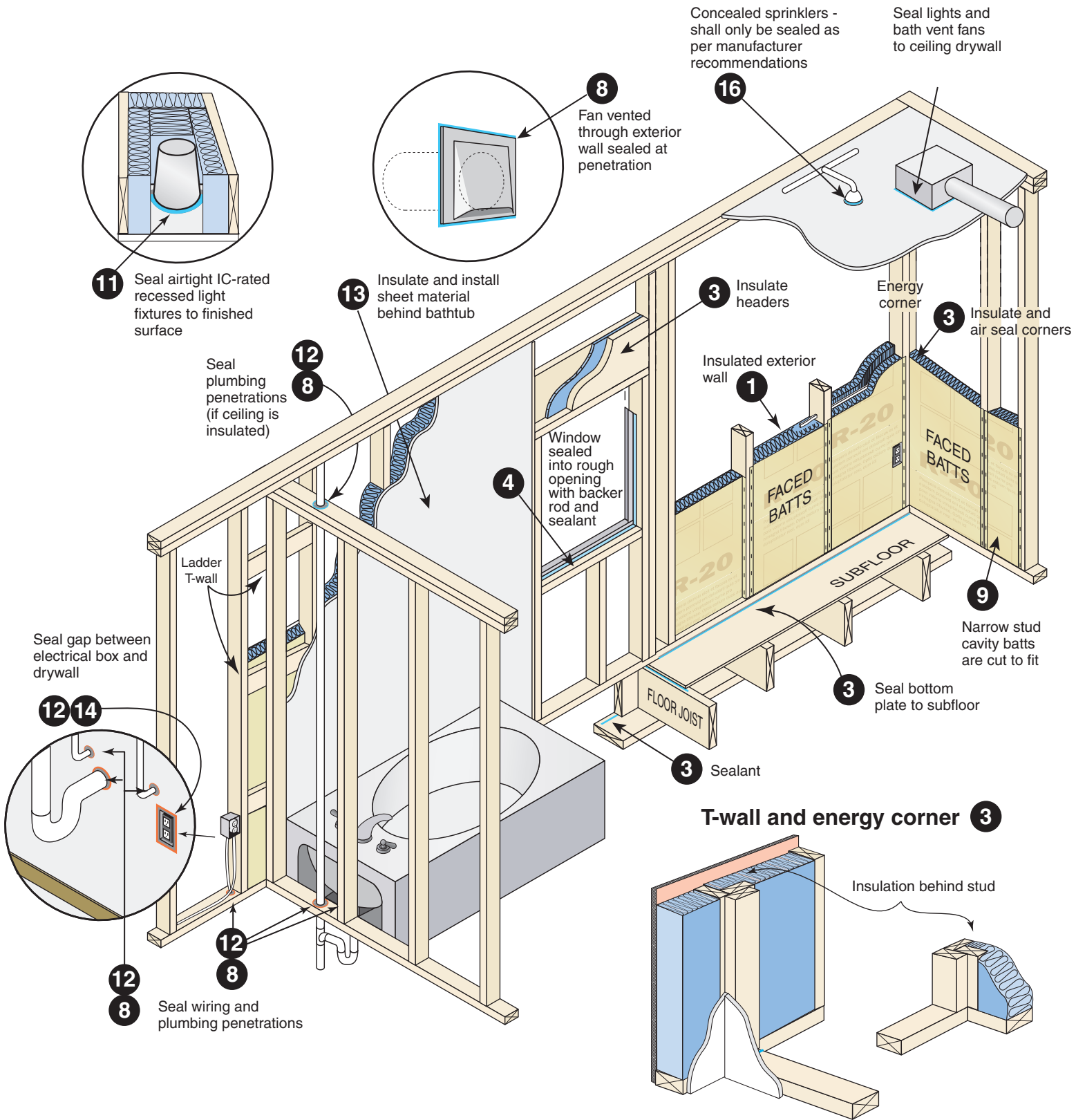

Disclaimer: This document was created by Southface for Performance Systems Development. It is intended solely to help graphically demonstrate the air leakage and insulation provisions of the 2018 IECC. It does not cover all air sealing locations, materials or techniques. Other code provisions may be applicable as well.

Air sealing key points *continued*

Chases and common by-passes

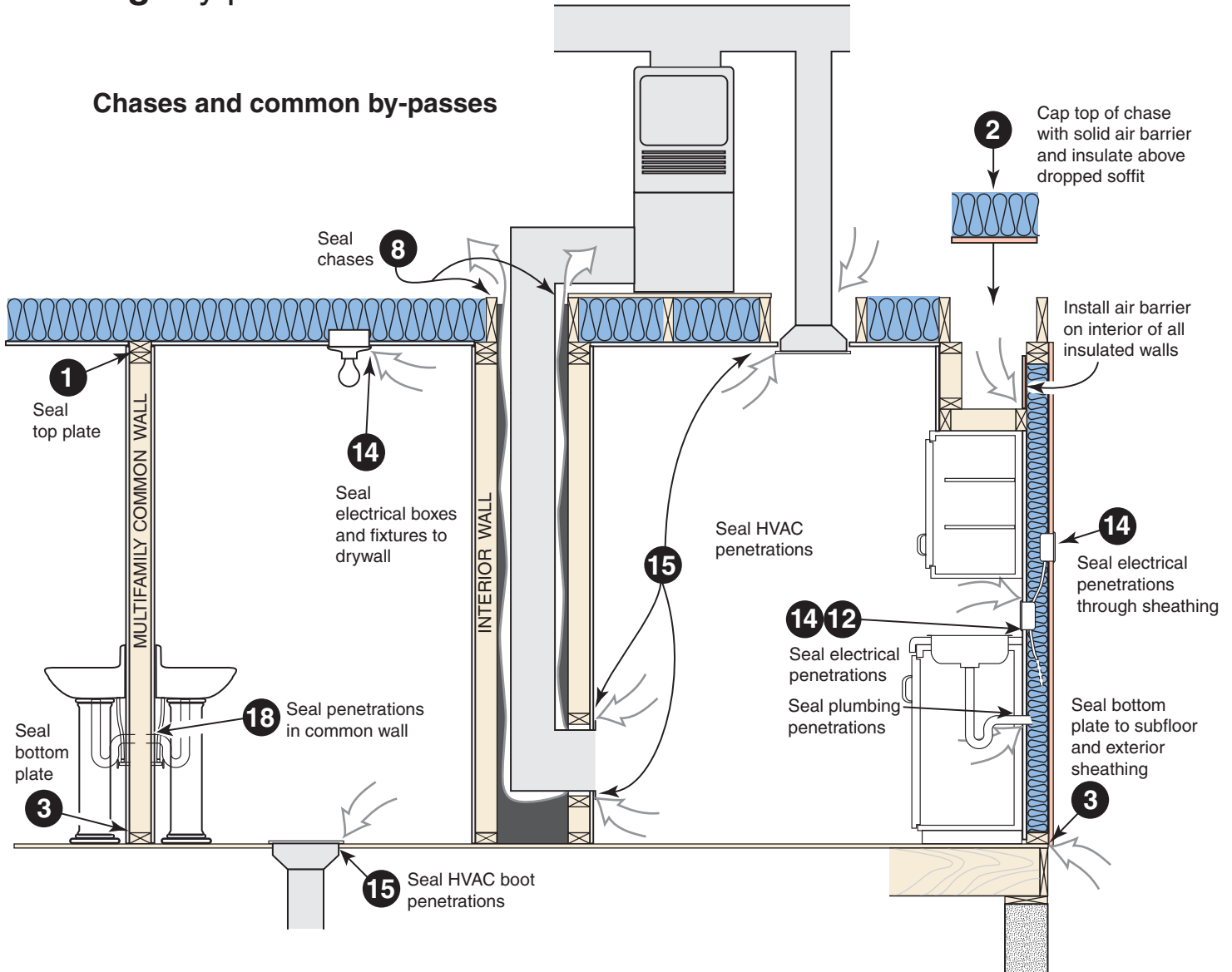

Shower/tub drain rough opening

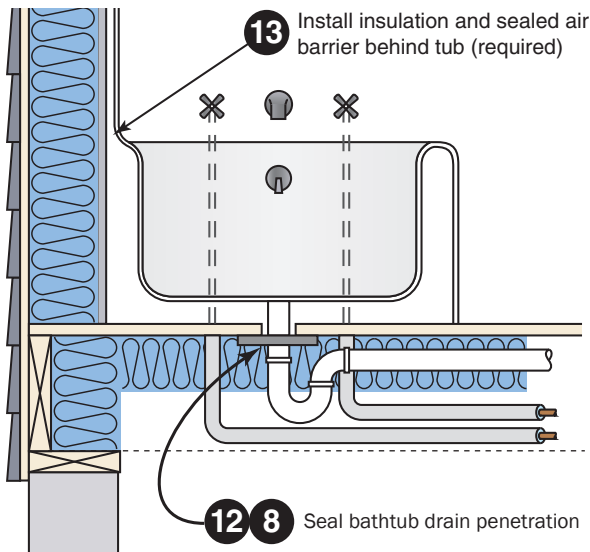

14

Electrical/phone box on exterior walls. The air barrier shall be installed behind electrical or communication boxes or air-sealed boxes shall be installed.

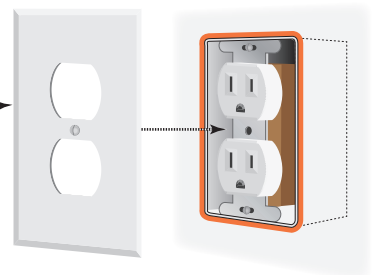

Disclaimer: This document was created by Southface for Performance Systems Development. It is intended solely to help graphically demonstrate the air leakage and insulation provisions of the 2018 IECC. It does not cover all air sealing locations, materials or techniques. Other code provisions may be applicable as well.

Air sealing key points *continued*

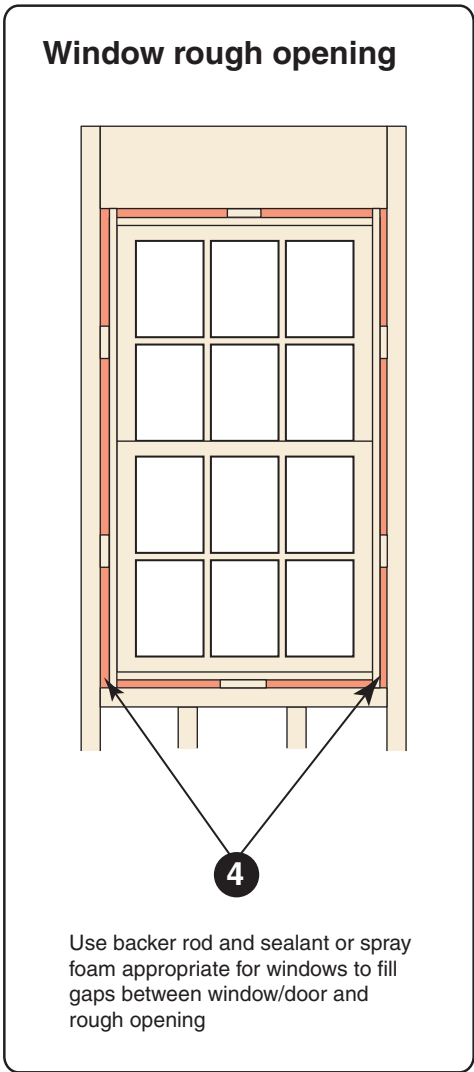

Wall cross-section

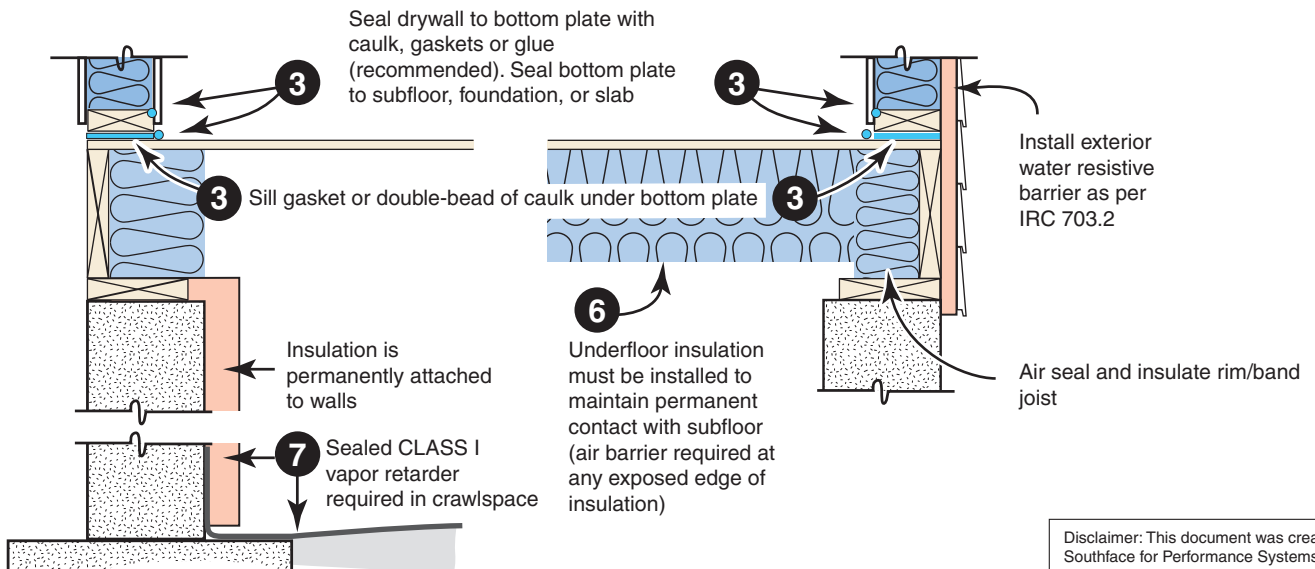
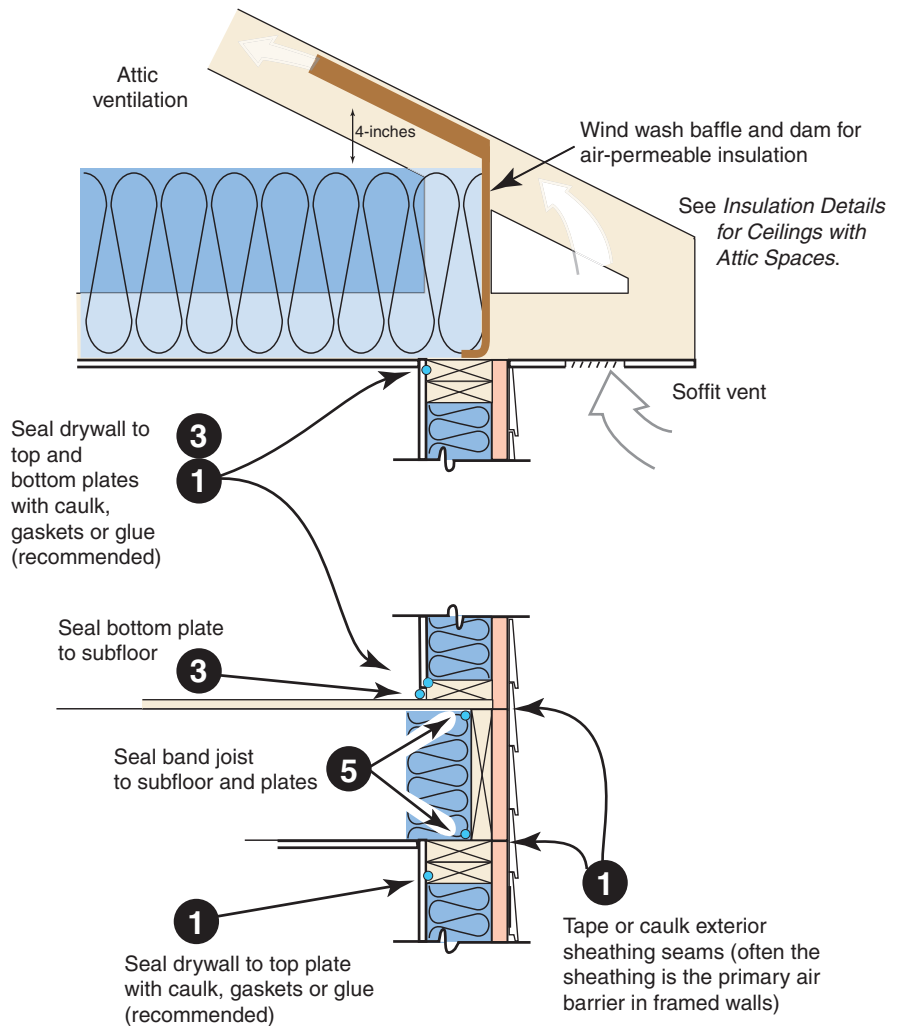

Disclaimer: This document was created by Southface for Performance Systems Development. It is intended solely to help graphically demonstrate the air leakage and insulation provisions of the 2018 IECC. It does not cover all air sealing locations, materials or techniques. Other code provisions may be applicable as well.

Air sealing key points *continued*

Combustion chase penetrations

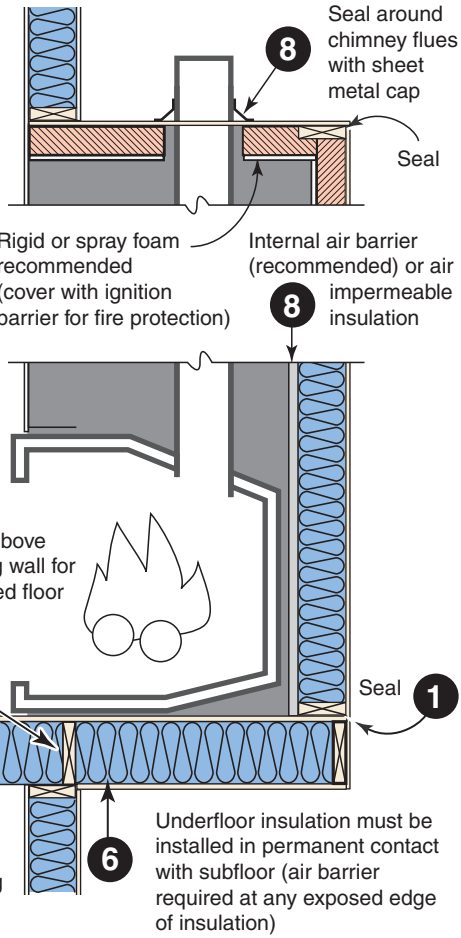

Exterior penetrations

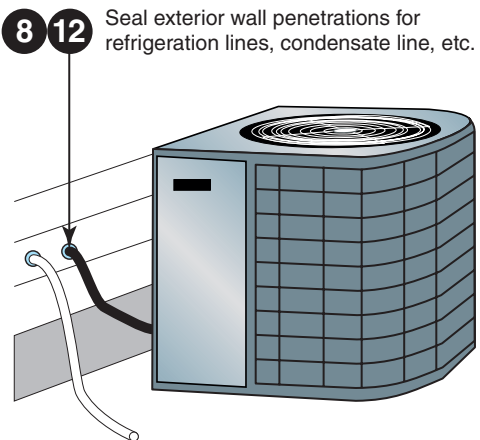

Rooms containing fuel-burning appliances*

Combustion air inlets
as per mechanical and/or fuel gas code

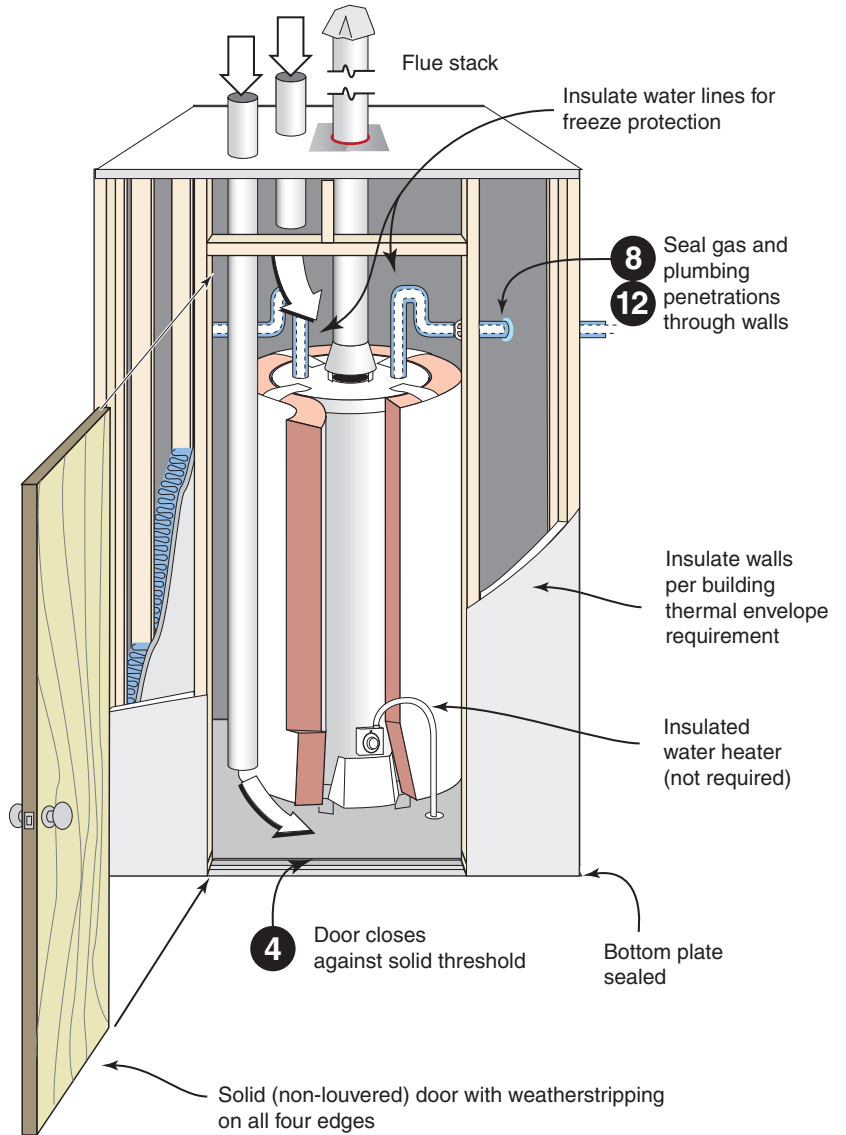

*Exceptions: Direct vent appliances (intake and exhaust) and wood-burning fireplaces with tight fitting doors and outdoor combustion air.

Disclaimer: This document was created by Southface for Performance Systems Development. It is intended solely to help graphically demonstrate the air leakage and insulation provisions of the 2018 IECC. It does not cover all air sealing locations, materials or techniques. Other code provisions may be applicable as well.

Air sealing key points *continued*

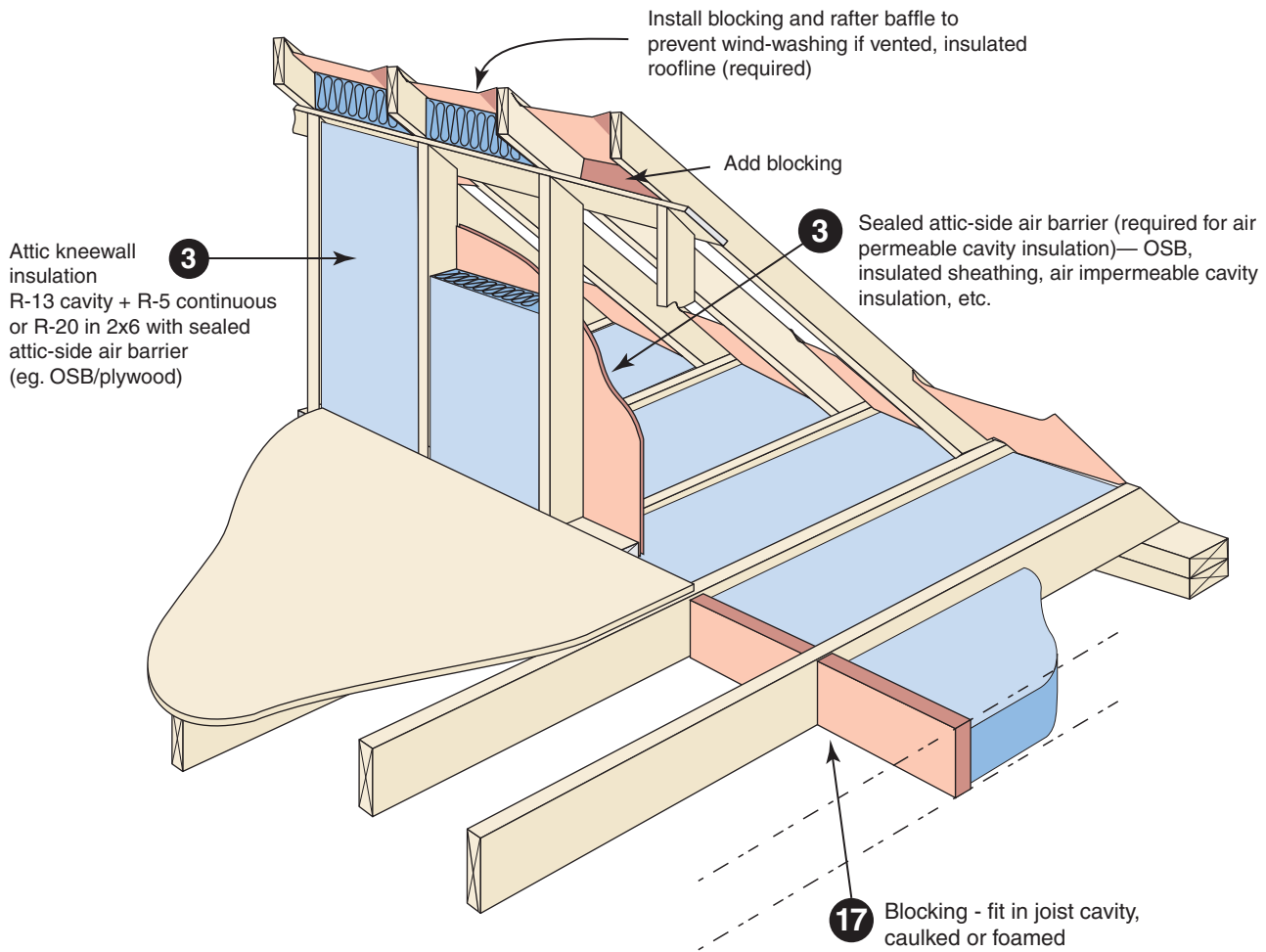

Attic kneewalls

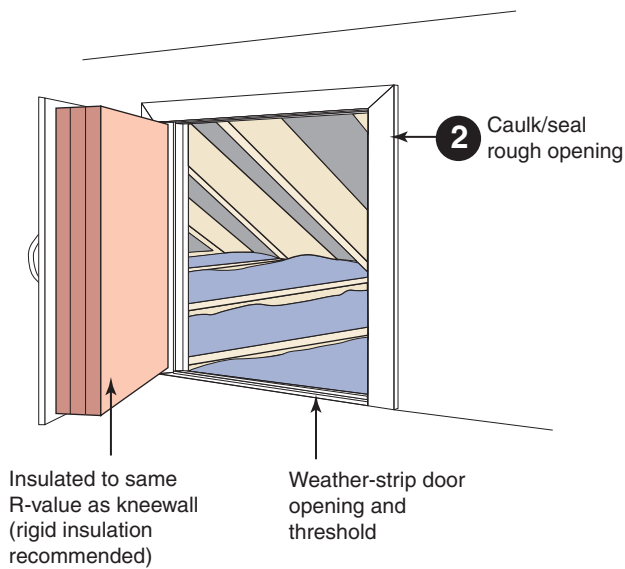

Two-level attic

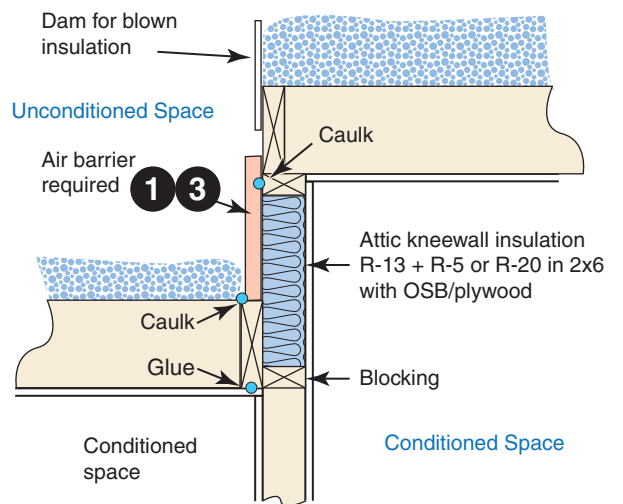

Disclaimer: This document was created by Southface for Performance Systems Development. It is intended solely to help graphically demonstrate the air leakage and insulation provisions of the 2018 IECC. It does not cover all air sealing locations, materials or techniques. Other code provisions may be applicable as well.

Air sealing key points *continued*

Attic scuttle

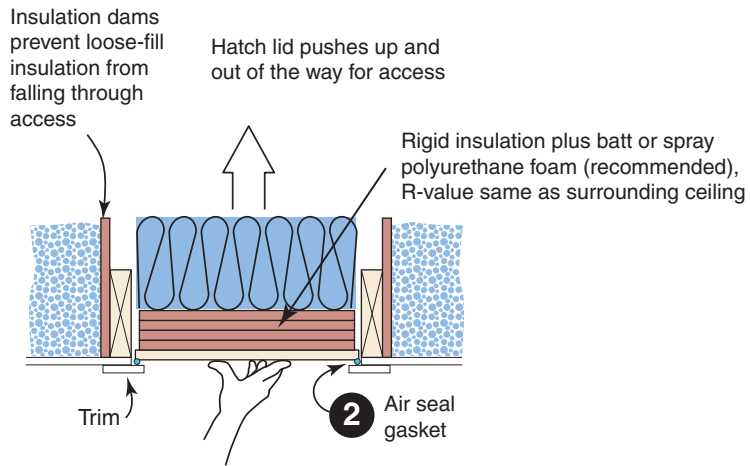

Attic pull-down stairs

Rigid insulation box forms lid for pull-down attic staircase (recommended)

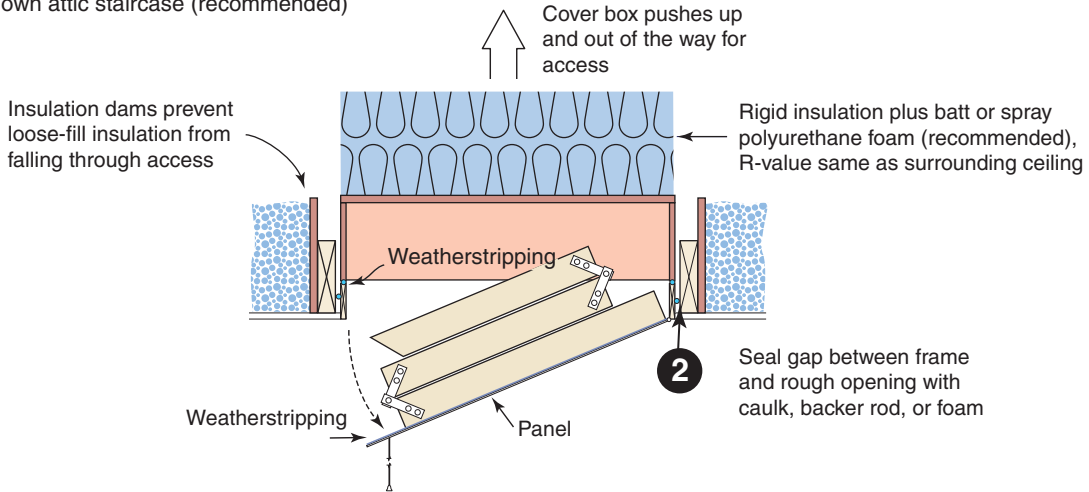

Boxed enclosure for staircase has rigid hinged lid with insulation on top

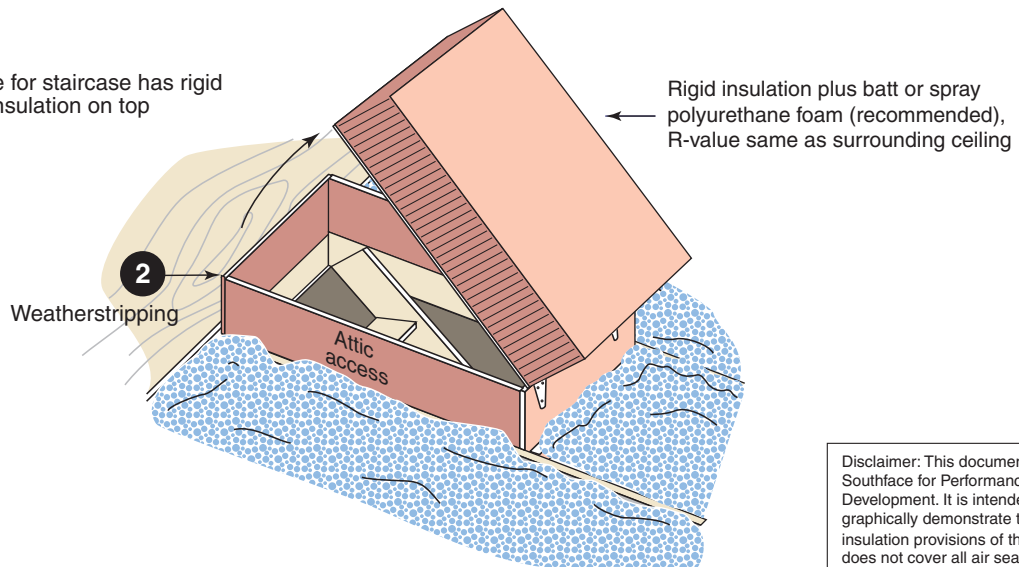

Disclaimer: This document was created by Southface for Performance Systems Development. It is intended solely to help graphically demonstrate the air leakage and insulation provisions of the 2018 IECC. It does not cover all air sealing locations, materials or techniques. Other code provisions may be applicable as well.

Garage blocking and sealing key points

Blocking, air sealing and insulation required above garage separation wall

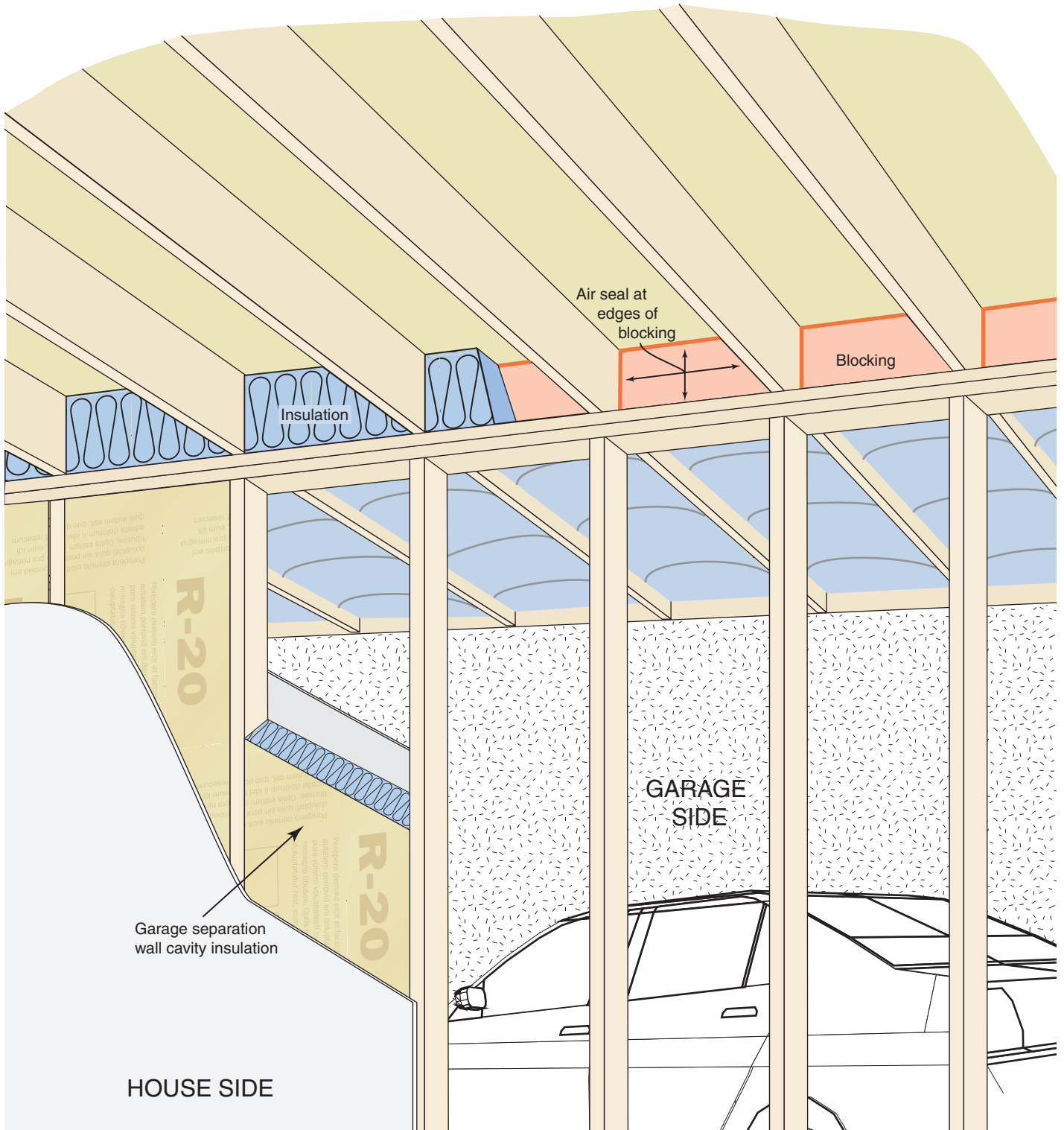

Disclaimer: This document was created by Southface for Performance Systems Development. It is intended solely to help graphically demonstrate the air leakage and insulation provisions of the 2018 IECC. It does not cover all air sealing locations, materials or techniques. Other code provisions may be applicable as well.

Air sealing key points *continued*

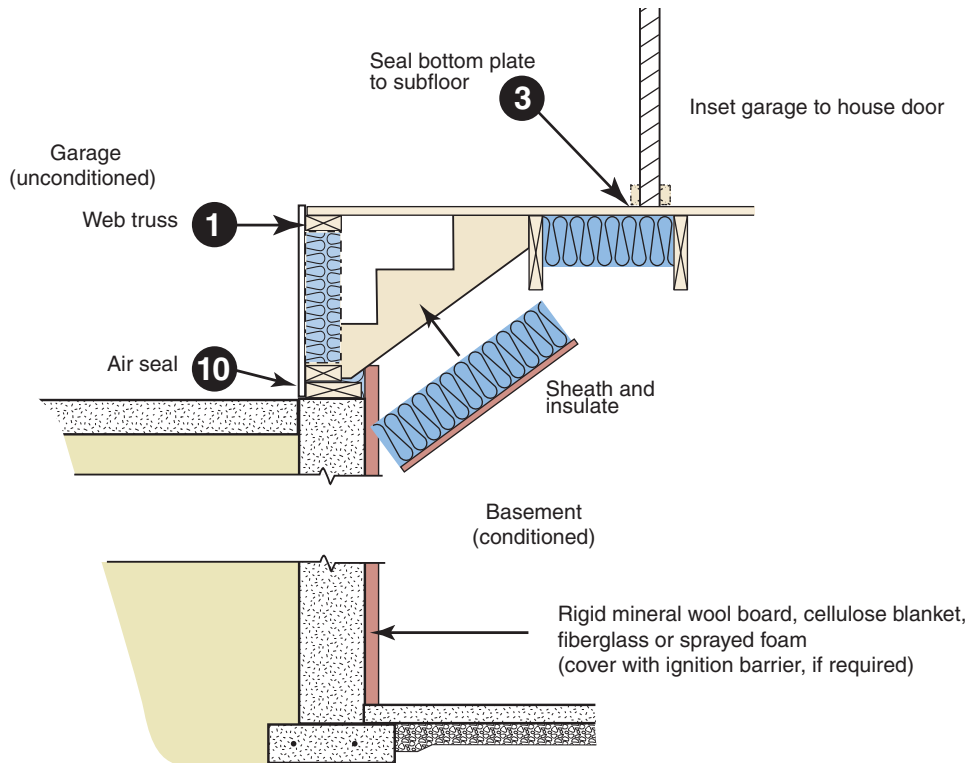
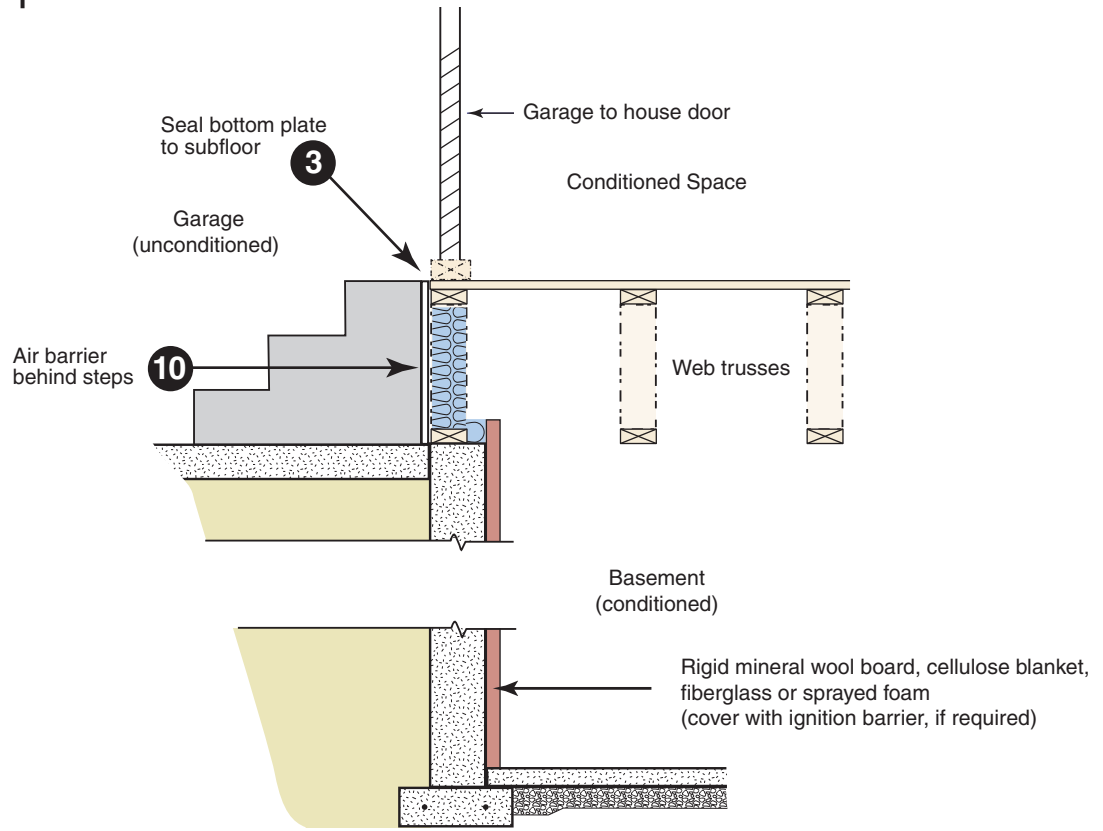

Disclaimer: This document was created by Southface for Performance Systems Development. It is intended solely to help graphically demonstrate the air leakage and insulation provisions of the 2018 IECC. It does not cover all air sealing locations, materials or techniques. Other code provisions may be applicable as well.

Duct Sealing key points

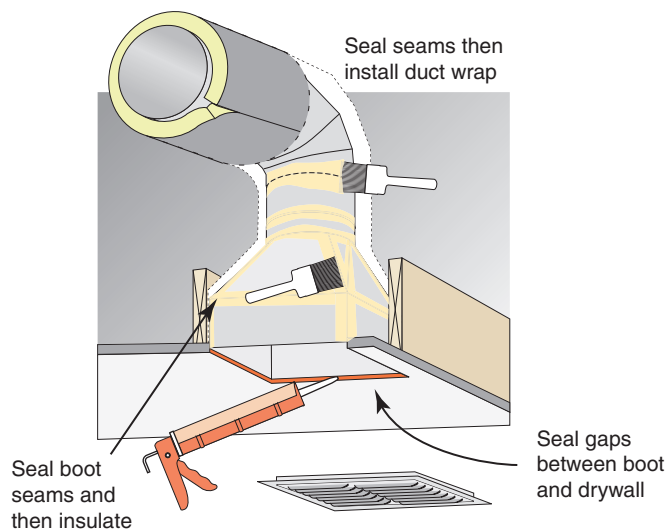
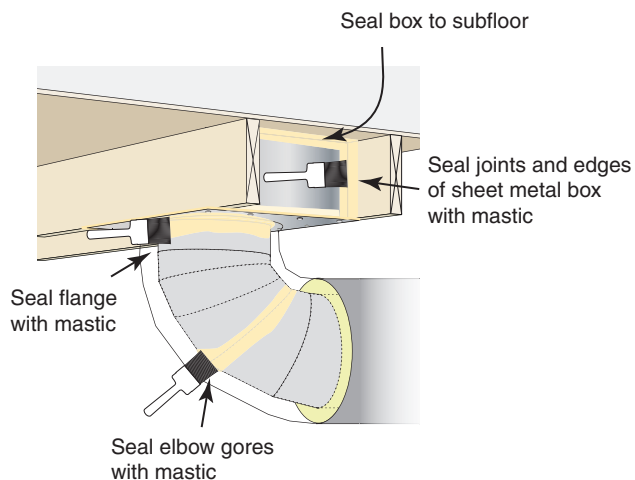
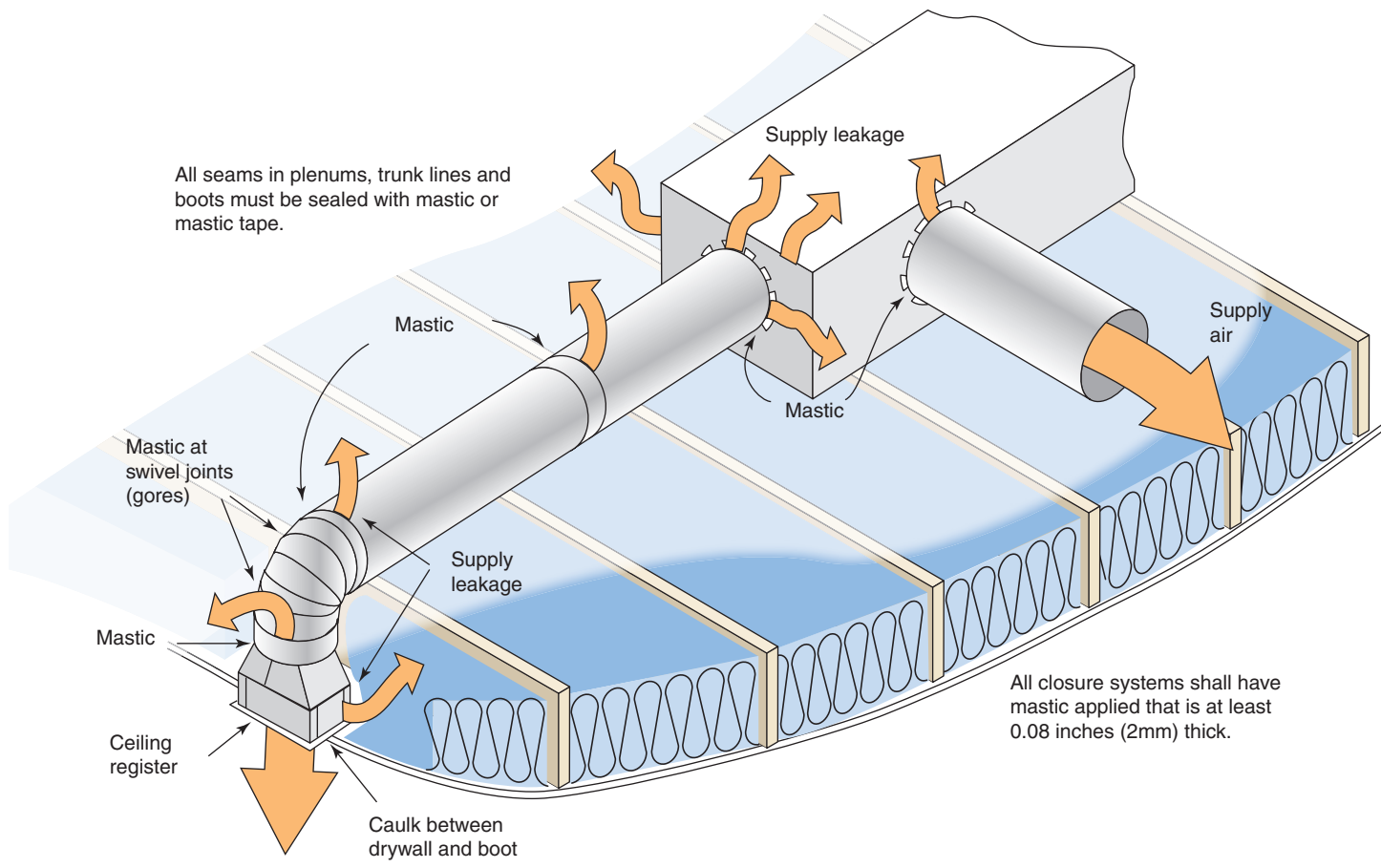

Disclaimer: This document was created by Southface for Performance Systems Development. It is intended solely to help graphically demonstrate the air leakage and insulation provisions of the 2018 IECC. It does not cover all air sealing locations, materials or techniques. Other code provisions may be applicable as well.

Air Handler Sealing key points

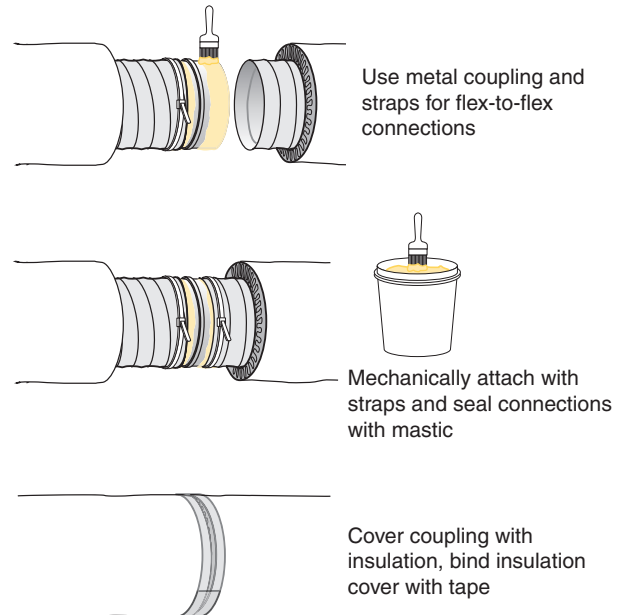
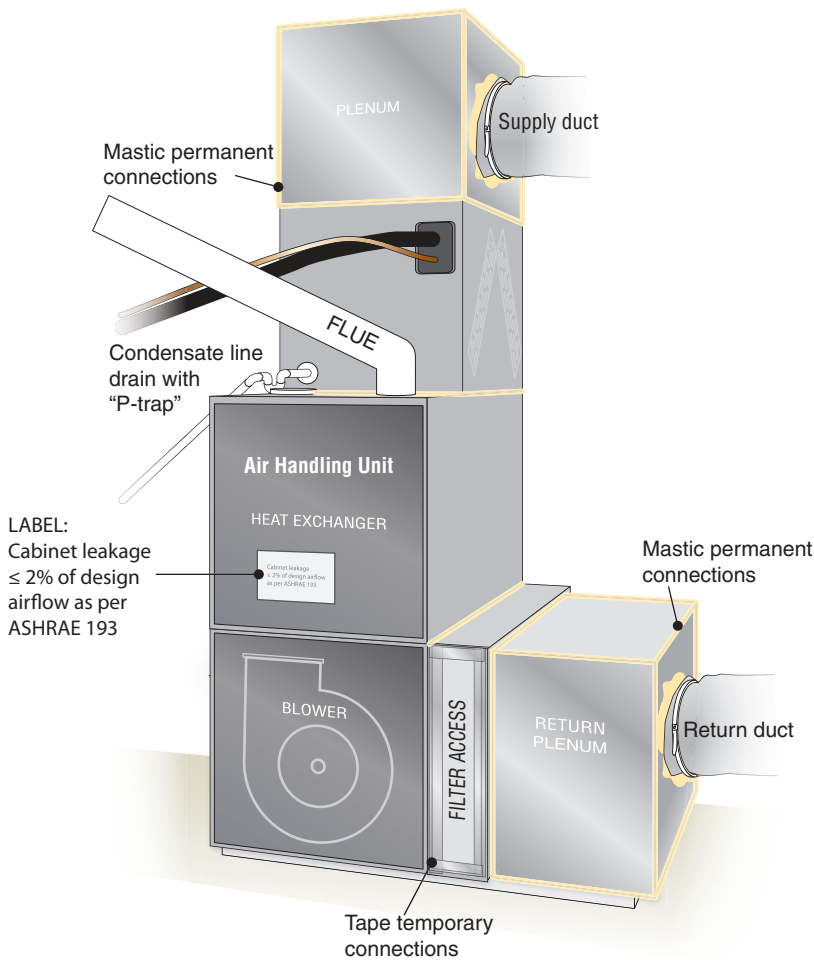
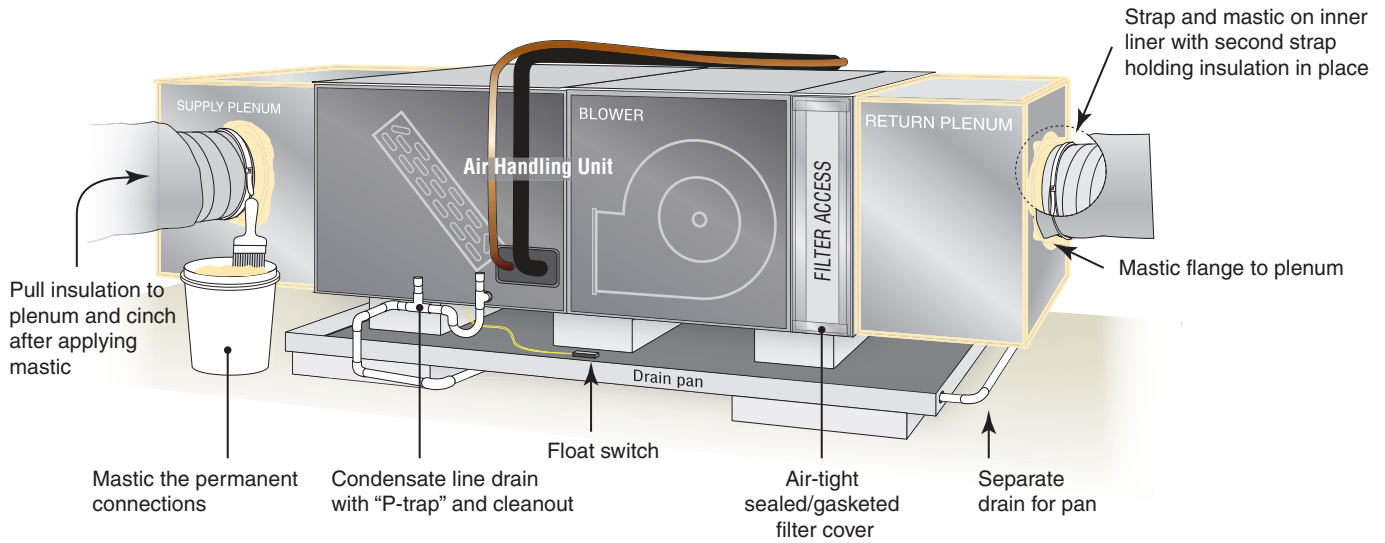

Disclaimer: This document was created by Southface for Performance Systems Development. It is intended solely to help graphically demonstrate the air leakage and insulation provisions of the 2018 IECC. It does not cover all air sealing locations, materials or techniques. Other code provisions may be applicable as well.

Air sealing key points *continued*

Multifamily

Multifamily Air-sealing Details

- 8 Cap and seal all chases including chases for grouped utility lines and radon vents

Seal penetrations in mechanical closet including penetrations for the:

- 8 supply plenum
 - 8 outside air ventilation
 - 8 12 refrigerant line
 - 12 plumbing
 - 12 14 electrical
 - 12 gas fuel
- 5 Seal band area at exterior sheathing side and all penetrations through band
 - 1 3 UL-compliant air sealing at drywall finishing for any wall adjacent to stairwell or elevator. Air seal this gap at every change in floor level
 - 8 Seal miscellaneous clustered penetrations through building envelope (e.g. refrigerant lines)

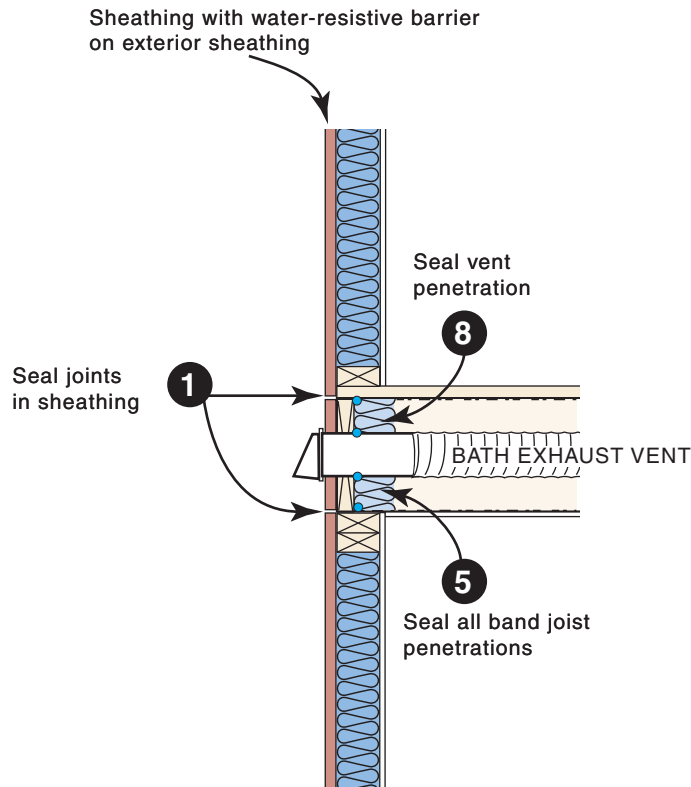

Disclaimer: This document was created by Southface for Performance Systems Development. It is intended solely to help graphically demonstrate the air leakage and insulation provisions of the 2018 IECC. It does not cover all air sealing locations, materials or techniques. Other code provisions may be applicable as well.

Air sealing key points *continued*

Multifamily

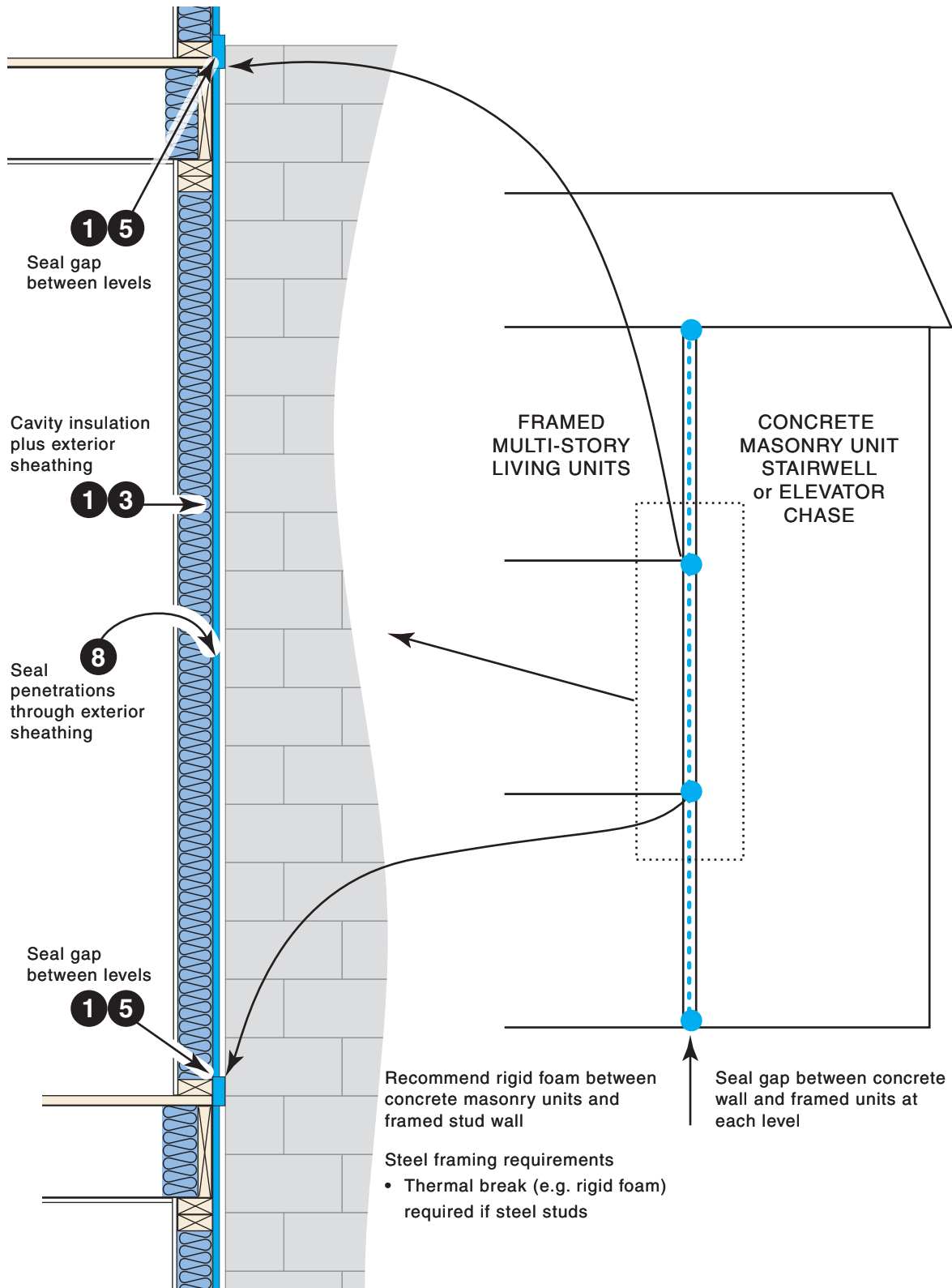

Disclaimer: This document was created by Southface for Performance Systems Development. It is intended solely to help graphically demonstrate the air leakage and insulation provisions of the 2018 IECC. It does not cover all air sealing locations, materials or techniques. Other code provisions may be applicable as well.

Air sealing key points *continued*

Multifamily Mechanical Closet

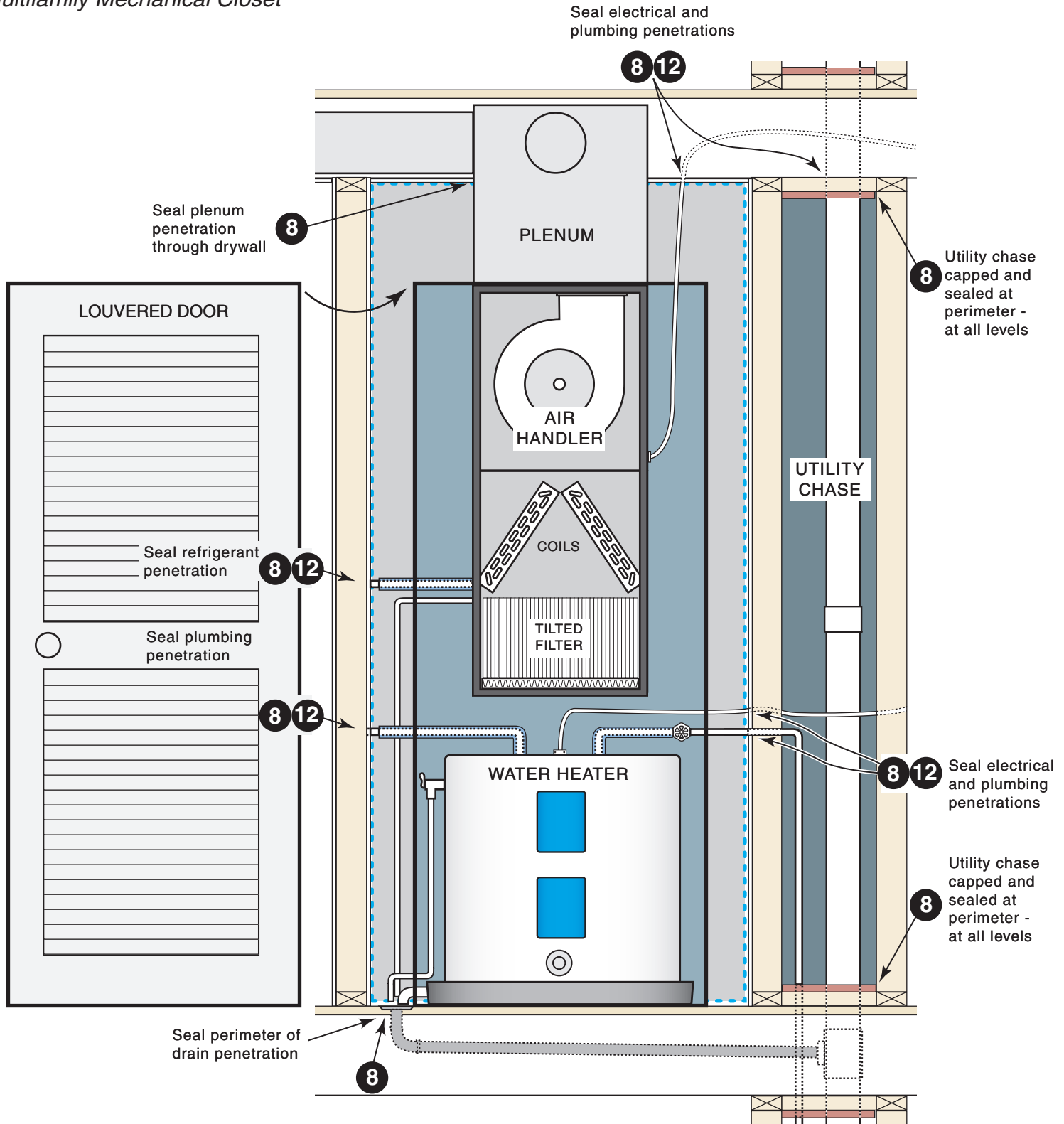

Disclaimer: This document was created by Southface for Performance Systems Development. It is intended solely to help graphically demonstrate the air leakage and insulation provisions of the 2018 IECC. It does not cover all air sealing locations, materials or techniques. Other code provisions may be applicable as well.

Building Thermal Envelope

— The basement walls, exterior walls, floor, roof, and any other building element that enclose conditioned space. This boundary also includes the boundary between conditioned space and any exempt or unconditioned space. —2018 IECC

The *building thermal envelope* is the barrier that separates the conditioned space from the outside or unconditioned spaces. The building envelope consists of two parts - an air barrier and a thermal barrier that must be both continuous and contiguous (touching each other). In a typical residence, the building envelope consists of the roof, walls, windows, doors, and foundation. Examples of unconditioned spaces include attics, vented crawlspaces, garages, and basements with ceiling insulation and no HVAC supply registers.

Example 1 – Prescriptive Compliance

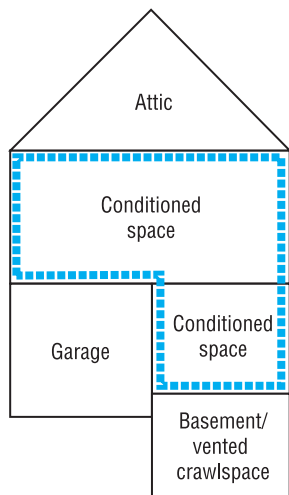

This is a conventional approach that likely locates all ductwork in unconditioned spaces.

Prescriptive R-values

- Flat ceiling: R-49
- Exterior walls: R-20 or 13+5
- Floor over garage and basement/crawl: R-30
- Ductwork sealed with mastic and insulated to R-8 in attic, R-6 in basement/crawlspace
- Garage⁴, attic and basement/crawl are unconditioned spaces

Example 2 – Prescriptive Compliance

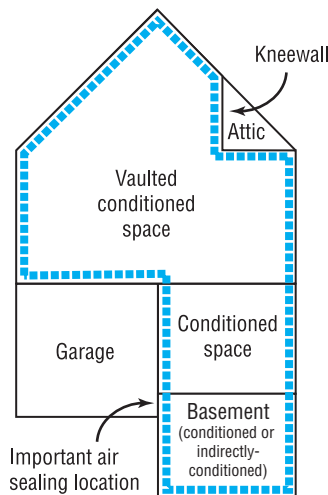

If supply registers deliver conditioned air to basement, it is considered conditioned. With no supply air, it is considered an indirectly-conditioned space.

Prescriptive R-values

- Flat ceiling: R-49
- Kneewalls: R-20 or 13+5¹
- Vaulted ceiling: R-30²
- Exterior walls: R-20 or 13+5
- Basement masonry walls: R-5
- Basement slab: R-10, 2ft³
- Ductwork sealed with mastic and insulated to R-8 in attic, R-6 in basement
- Garage⁴ and attic are unconditioned spaces

Example 3 – Prescriptive Compliance

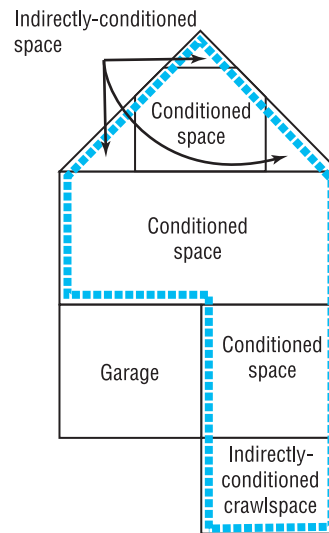

The top conditioned floor functions as a vaulted ceiling with interior walls although it appears to have kneewalls and a flat ceiling. An advantage of this approach is that all upstairs ductwork is located inside the building envelope.

The crawlspace walls are insulated and do not contain vents. The crawlspace ground is covered with 100% plastic and functions as a “mini-basement.”

Prescriptive R-values

- Vaulted ceiling: R-30 air-impermeable foam insulation²
- Exterior walls: R-13 + R-5 sheathing
- Crawlspace walls: R-15 continuous
- Garage⁴ is unconditioned space

1 An attic kneewall is any vertical wall that separates conditioned space from an unconditioned attic. A sealed attic-side air barrier (OSB, foil-faced sheathing, etc.) is required when using air permeable insulation.

2 Reduction from R-49 to R-30 limited to 500 ft² or 20% of insulated ceiling area, whichever is less.

3 Interior slab insulation must extend downward from the top of the slab creating a thermal break between the slab edge and the stem wall. Exterior slab insulation must extend downward from the top of the slab with above-grade insulation protected from UV and physical damage. Insulation must continue vertically or horizontally for 2 ft below grade.

4 Although there is nothing to prevent the garage walls from being insulated, due to indoor air quality concerns, the garage should never be considered inside the building.

Disclaimer: This document was created by Southface for Performance Systems Development. It is intended solely to help graphically demonstrate the air leakage and insulation provisions of the 2018 IECC. It does not cover all air sealing locations, materials or techniques. Other code provisions may be applicable as well.

Insulation Details for Ceilings with Attic spaces

Rafter and Truss

Standard Truss
with tapered
insulation depth

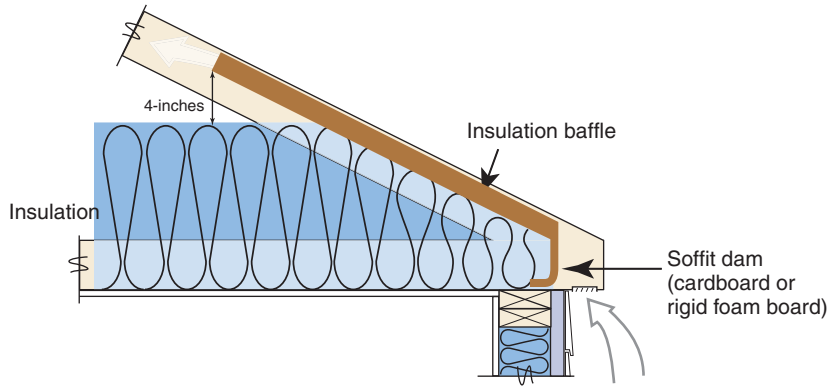

Note: Wind wash baffle and air-permeable insulation dam. For air permeable insulation in vented attics, baffles shall be installed adjacent to soffit and eave vents. A minimum of a 1-inch of space shall be provided between the insulation and the roof sheathing and at the location of the vent. The baffle shall extend over the top of the insulation inward until it is at least 4 inches vertically above the top of the insulation. Any solid material such as cardboard or thin insulating sheathing shall be permissible as the baffle.

Energy Truss
with full height insulation
(recommended)

NOTE:
R-38 complete coverage
is deemed equivalent to
prescriptive R-49

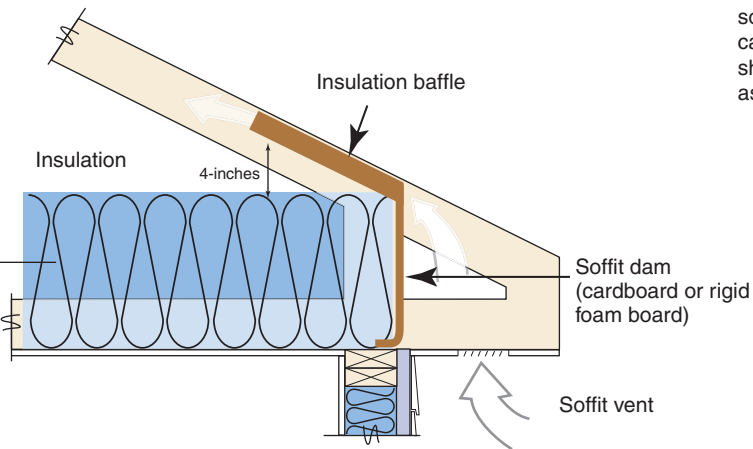

Standard rafter
and top plate
with tapered
insulation depth

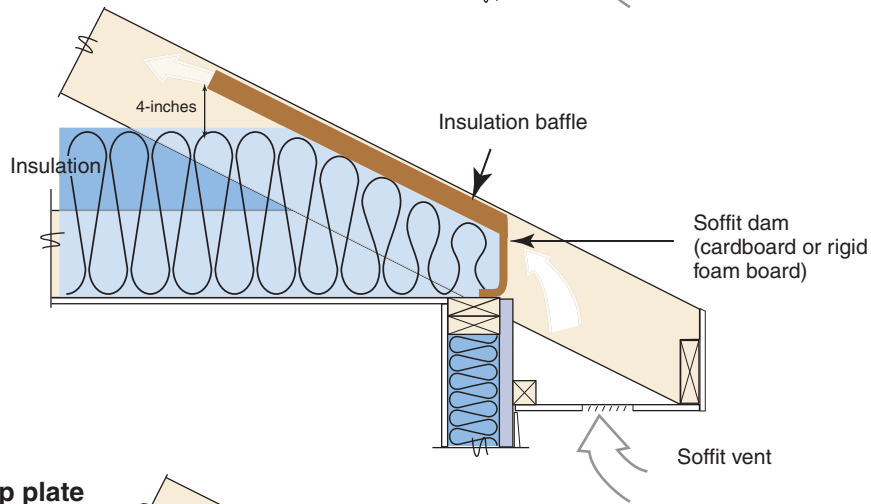

Rafter on raised top plate
with full height insulation
(recommended)

NOTE:
R-38 complete coverage
is deemed equivalent to
prescriptive R-49

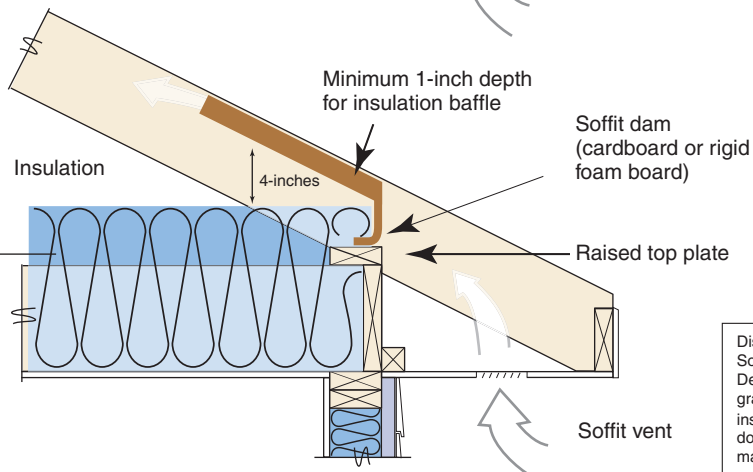

Disclaimer: This document was created by Southface for Performance Systems Development. It is intended solely to help graphically demonstrate the air leakage and insulation provisions of the 2018 IECC. It does not cover all air sealing locations, materials or techniques. Other code provisions may be applicable as well.

Roofline Installed Insulation Options

Reference Table 402.1.2 and 402.1.4 in 2018 IECC. Refer to Section 806.5 "Unvented Attic Assemblies" in the 2015 IRC for additional detail.

Vaulted unvented attic – roofline air-impermeable insulation (e.g., spray foam insulation)

Air impermeable insulation (e.g., open- or closed-cell spray foam) R-20 minimum

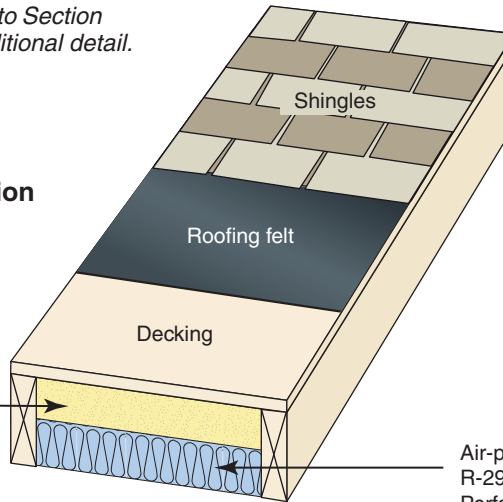

Air-permeable insulation, additional R-29 minimum or use REScheck, Performance or ERI

Vaulted unvented attic – roofline air-permeable insulation (e.g., fiberglass, cellulose insulation)

Air impermeable insulation (e.g. rigid foam board)

Air-permeable insulation (e.g., fiberglass, cellulose insulation) R-29 minimum or use REScheck, Performance or ERI

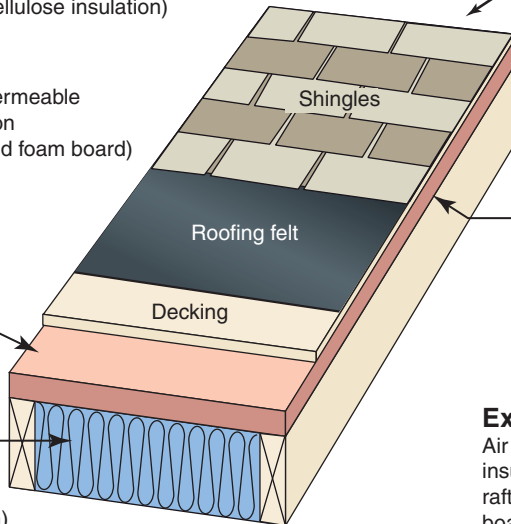

Example 1

Air impermeable insulation continuous above rafters (e.g. rigid foam board) combined with air-permeable insulation (e.g., fiberglass, cellulose insulation)

R-20 minimum

R-20 minimum

Example 2

Air impermeable insulation between rafters (e.g. rigid foam board or spray foam) combined with air-permeable insulation (e.g., fiberglass, cellulose insulation)

Air-permeable insulation (e.g., fiberglass, cellulose insulation) R-29 minimum or use REScheck, Performance or ERI

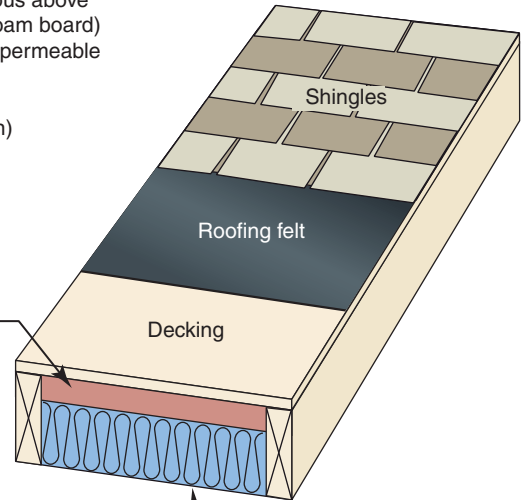

Cathedralized vented ceiling – roofline air-permeable insulation (e.g., fiberglass, cellulose insulation)

Air-permeable insulation (e.g., fiberglass, cellulose insulation) R-49 minimum

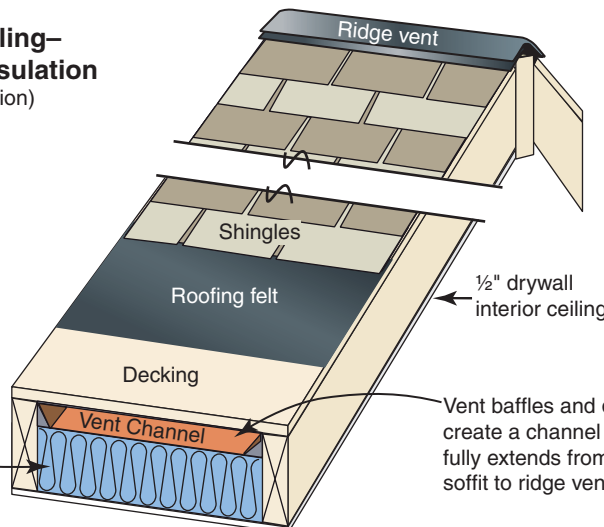

Vent baffles and dams create a channel that fully extends from soffit to ridge vent

Disclaimer: This document was created by Southface for Performance Systems Development. It is intended solely to help graphically demonstrate the air leakage and insulation provisions of the 2018 IECC. It does not cover all air sealing locations, materials or techniques. Other code provisions may be applicable as well.

IECC Insulation Installation Details

All insulation that makes up portions of the building thermal envelope shall be installed at a grade I quality in accordance with ICC/RESNET 301, per manufacturer's instructions, and IECC Table 402.1.1.

Two criteria affect installed insulation quality: **voids/gaps** (in which no insulation is present in a portion of the overall insulated surface) and **compression/incomplete fill** (in which the insulation does not fully fill out or extend to the desired depth).

Insulation Installation Guidelines:

Voids/Gaps

- Voids or gaps in the insulation are minimized (only occasional and very small gaps)

Compression/Incomplete Fill

- Compression/Incomplete Fill for both *air permeable insulation* (e.g., fiberglass, cellulose) and *air impermeable insulation* (e.g., spray polyurethane foam) is minimal.

Additional Wall Insulation Requirements

- All vertical air permeable insulation shall be installed in substantial contact with an air barrier on all six (6) sides.
Exception: Unfinished basements and rim/band joist cavity insulation (insulation shall be restrained to stay in place). For unfinished basements, air permeable insulation and associated framing in a framed cavity wall shall be installed less than ¼" from the basement wall surface.
- Attic kneewall details – Attic kneewalls shall be insulated to a total R-value of at least R-20 cavity or 13+5 cavity and continuous. Air permeable insulation shall be installed with a fully sealed attic-side air barrier (e.g., OSB with seams caulked, rigid insulation with joints taped, etc.). Attic kneewalls with air impermeable insulation shall not require an additional attic-side air barrier.

Underfloor insulation that makes up portions of the building thermal envelope shall be installed to meet the following guidelines.

Two criteria affect installed insulation grading: **voids/ gaps** (in which no insulation is present in a portion of the overall insulated surface) and **compression/incomplete fill** (in which the insulation does not fully fill out or extend to the desired depth).

Voids/Gaps

- Voids or gaps in the insulation are minimal

Compression/Incomplete Fill

- Compression/Incomplete Fill for both *air permeable insulation* (e.g., fiberglass, cellulose) and *air impermeable insulation* (e.g., spray polyurethane foam) is minimal.
- Air-permeable underfloor insulation shall be permanently installed against the subfloor decking. Adequate insulation supports (e.g., wire staves) for air permeable insulation shall be installed at least every 18-24".
Exception: The floor framing-cavity insulation shall be permitted to be in contact with the topside of sheathing or continuous insulation installed on the bottom side of floor framing where combined with insulation that meets or exceeds the minimum wood frame wall R-value and that extends from the bottom to the top of all perimeter floor framing members.

Disclaimer: This document was created by Southface for Performance Systems Development. It is intended solely to help graphically demonstrate the air leakage and insulation provisions of the 2018 IECC. It does not cover all air sealing locations, materials or techniques. Other code provisions may be applicable as well.

Wall Insulation key points

Voids / Gaps

Passing Grade 

Insulation is notched and completely surrounds electrical box

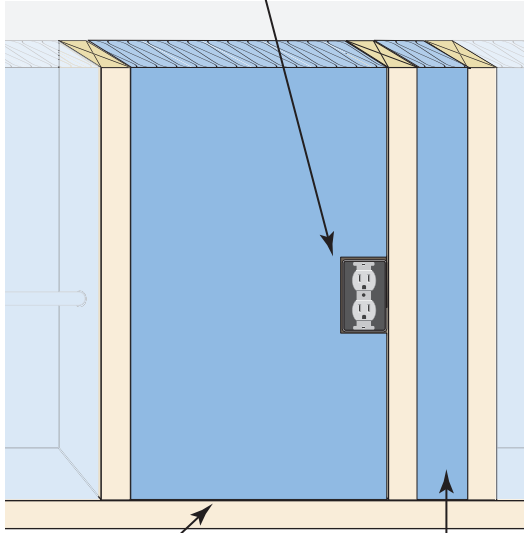

Insulation fully fills cavity at top and bottom

Narrow cavity fully insulated

Unacceptable Installation 

Incomplete insulation coverage around electrical box

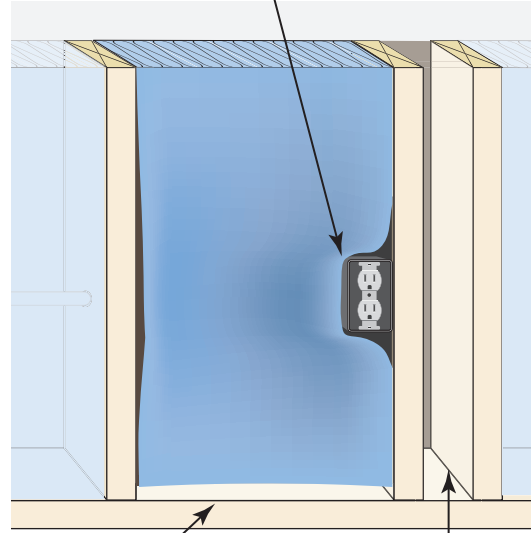

Insulation does not extend to bottom of cavity

Narrow cavity not insulated

Compression / Incomplete Fill

Passing Grade 

Insulation is slit around electrical wire

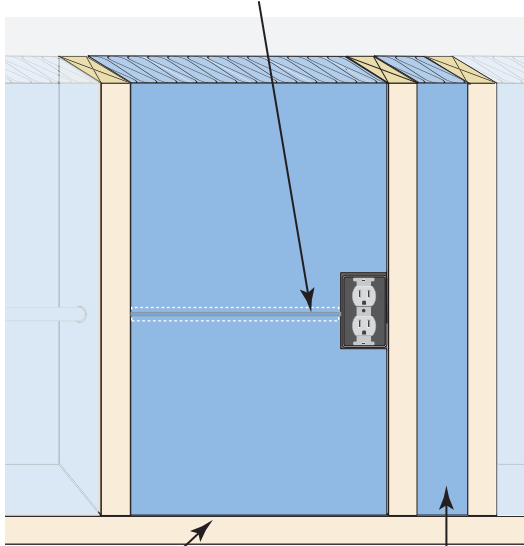

Insulation extends from front to back and fully fills entire cavity

Proper width insulation fully fills narrow cavity

Unacceptable Installation 

Insulation is compressed behind electrical wire

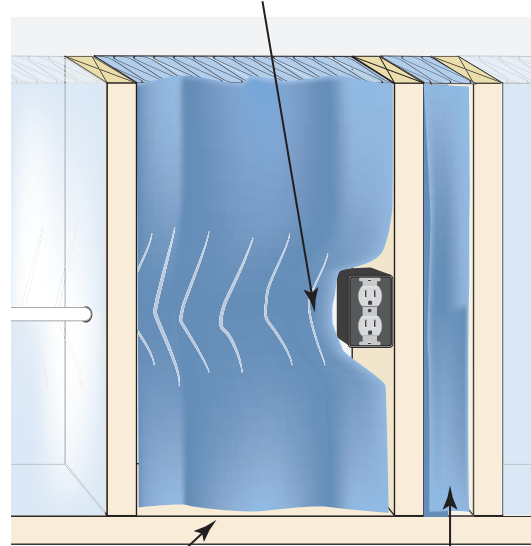

Insulation does not fully fill entire cavity

Improper width insulation is compressed into narrow cavity

Disclaimer: This document was created by Southface for Performance Systems Development. It is intended solely to help graphically demonstrate the air leakage and insulation provisions of the 2018 IECC. It does not cover all air sealing locations, materials or techniques. Other code provisions may be applicable as well.

Ceiling Insulation key points

Passing Grade 

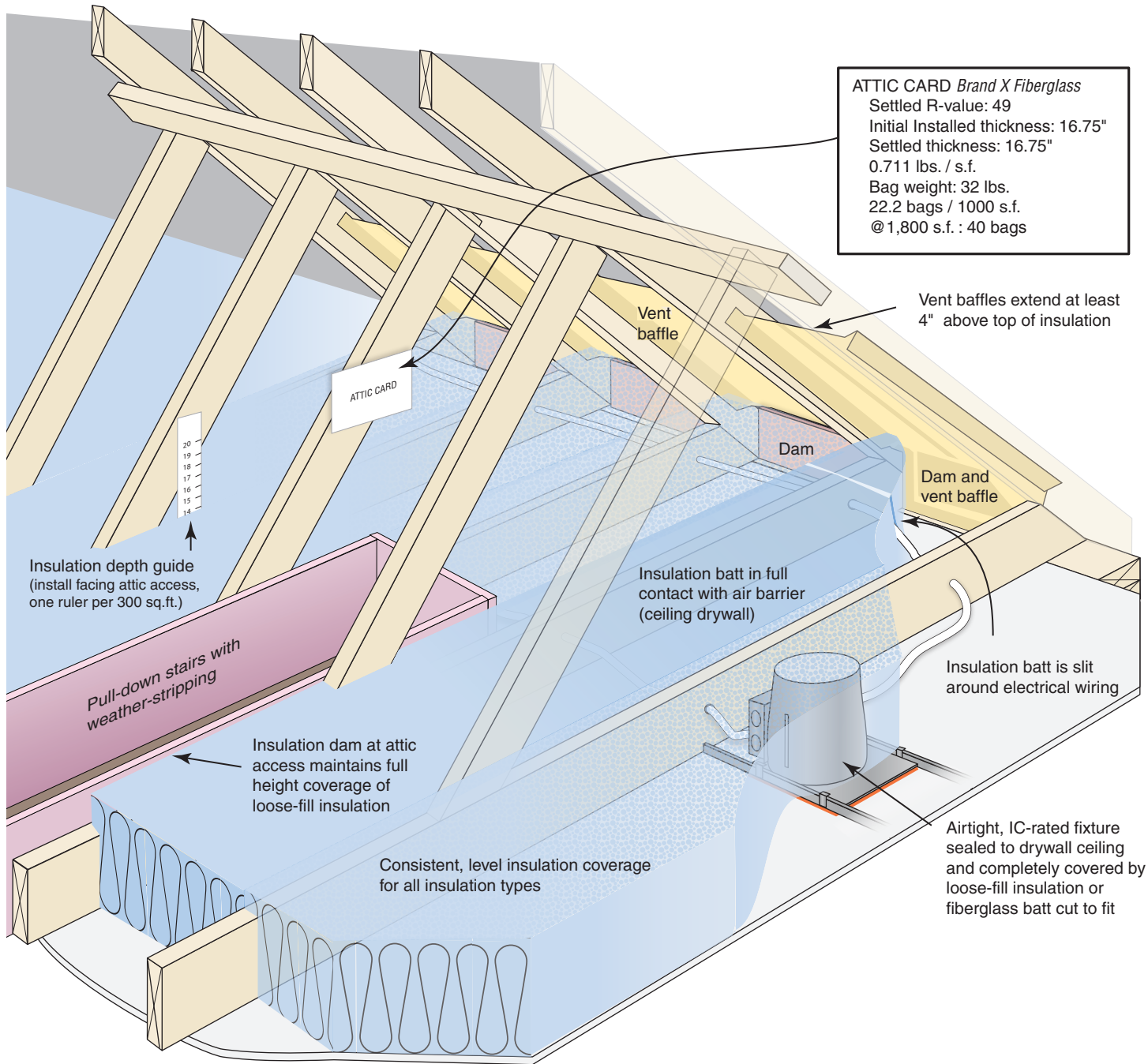

Disclaimer: This document was created by Southface for Performance Systems Development. It is intended solely to help graphically demonstrate the air leakage and insulation provisions of the 2018 IECC. It does not cover all air sealing locations, materials or techniques. Other code provisions may be applicable as well.

Ceiling Insulation key points

Unacceptable installation 

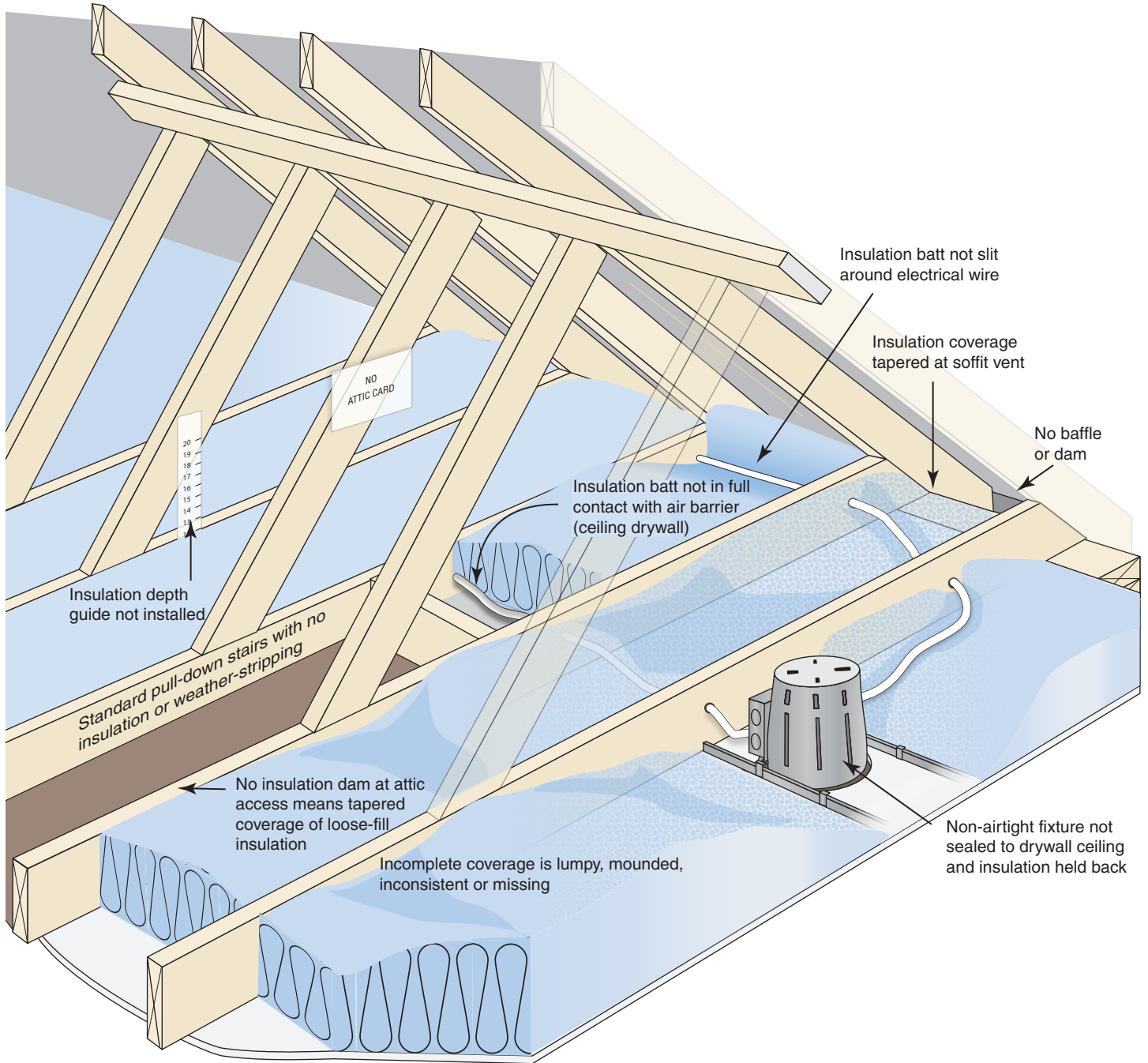

Disclaimer: This document was created by Southface for Performance Systems Development. It is intended solely to help graphically demonstrate the air leakage and insulation provisions of the 2018 IECC. It does not cover all air sealing locations, materials or techniques. Other code provisions may be applicable as well.

Floor Insulation key points

Passing Grade

Installed insulation is in complete contact with air barrier (subfloor)

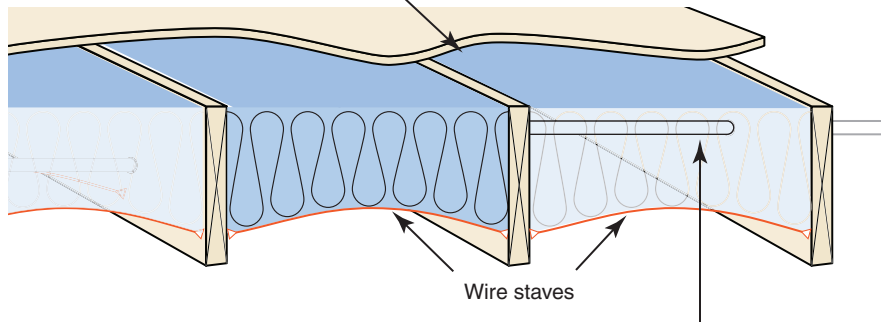

Insulation coverage is complete

Insulation is slit around plumbing and wiring and securely fastened with minimal compression

Unacceptable Installation

Insulation is not installed in complete contact with air barrier (subfloor)

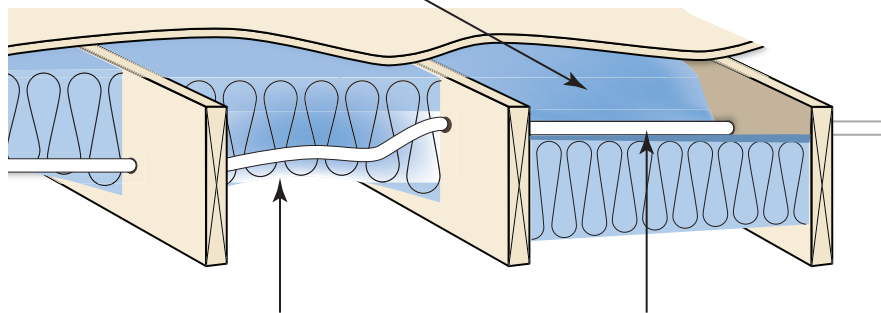

Insulation coverage is incomplete due to obstructions (plumbing, electrical, ductwork, etc.)

Insulation is compressed around plumbing and wiring and is not securely fastened

Disclaimer: This document was created by Southface for Performance Systems Development. It is intended solely to help graphically demonstrate the air leakage and insulation provisions of the 2018 IECC. It does not cover all air sealing locations, materials or techniques. Other code provisions may be applicable as well.